

# DTT-50 & DTT-60 Telephones

## Installation & Operation

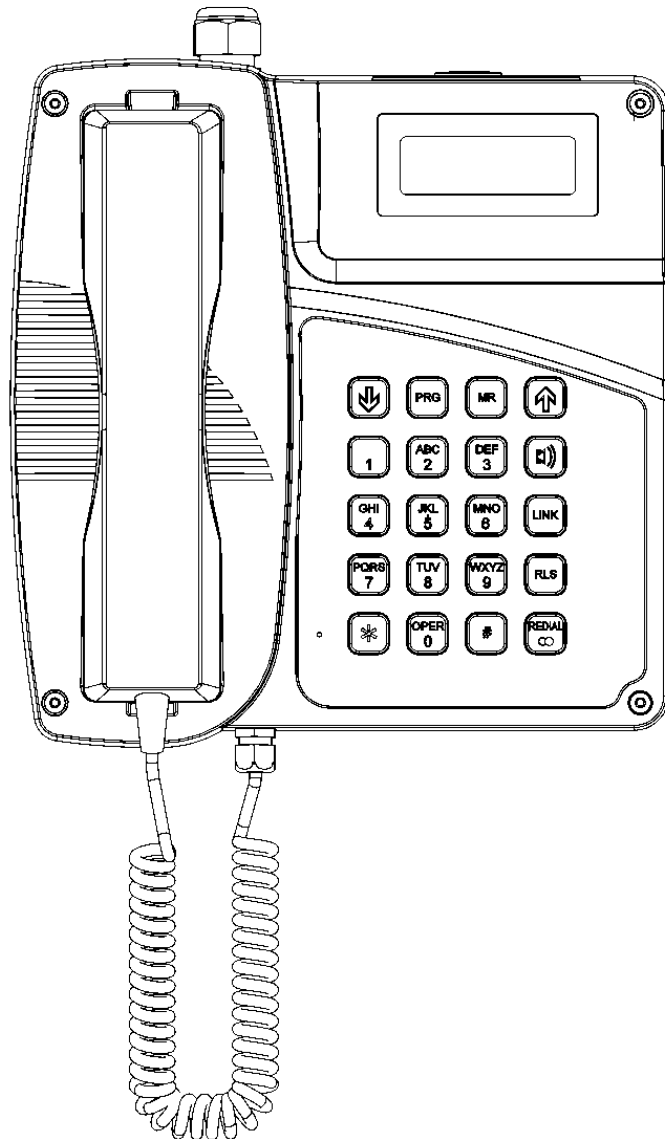

## **Table of Contents**

Package Contents .....	2
Models .....	2
Accessories .....	2
Overview .....	3
Features .....	3
Installation .....	6
Wiring .....	7
Retrofitting Headset/Supplemental Receiver, Strobe Light/Ringer.....	8
Field Repairs & Adjustments .....	9
Operating Modes and Software Features .....	11
Product Specifications .....	18
Replacement Parts .....	19
Warranty .....	20
Disclaimer.....	20
Warning .....	20
Service Telephone Number.....	20
Feedback.....	20
Guardian Product Return .....	21
Cleaning Tips for Guardian Telephones.....	22

## **Table of Figures**

Figure 1 - Features .....	4
Figure 2 - Overall Dimensions .....	4
Figure 3 - Wall Installation of Base.....	5
Figure 4 - Wiring .....	5
Figure 5 - Temporary Mounting for Wiring.....	7

## **Package Contents**

- (1) DTT-50 or DTT-60 Telephone
- (1) Installation & Operation Manual
- (1) Parts bag containing handset clips & screws, 3mm Allen key for faceplate screws & one Ring Detect Relay Enable jumper wire.

## **Models**

- P3027 DTT-50 Telephone With Curly Cord
- P3028 DTT-60 Telephone With Armored Cord

## **Accessories**

- P3031 Headset Kit
- P3024 Supplemental Receiver Kit

## Overview

### ***DTT Telephones***

DTT telephones provide safe, reliable communications in areas that are prone to high humidity, chemical vapors, dust and physical abuse. Hands Free operation is standard on all models and the telephones can be programmed for speed dialing. All models have the option of installing a Supplemental receiver that can be held against the ear opposite to the handset, in order to improve speech recognition in noisy environments. In place of a Supplemental receiver a headset providing even greater flexibility can be installed.

## Features

### ***Housing and Handset***

- high impact thermoset – static dissipative

### ***Mounting***

- desk top or wall mounted

### ***Audio Modes***

- handset and hands-free or optional headset

### ***Resettable Fuse***

- prevents damage to the electronic circuits in the event of a high voltage spike on the telephone line

### ***Magnetic Reed Hook Switch***

- no moving parts

### ***LCD Display***

- for ease of user interface, multi-language capable

### ***Built In Ring Detect Relay***

- 250VAC 5 Ampere Ring Detect Relay, no need for external RDR

### ***Tone (DTMF)/Pulse Operation***

- factory set to tone (DTMF) dialing
- 60:40 or 66:33 pulse dialing can be ordered or configured in the field

### ***Handset Cord***

- 6' heavy duty curly cord on DTT-50
- armored cord on DTT-60

### ***Hearing-Aid Compatible (HAC) Receiver***

- compatible with inductively coupled hearing-aid devices

### ***Receiver Volume Control***

- Switch on keypad provides 15dB of audio range

### ***Wide Temperature Range***

- -30° C to +60° C (-22° F to +140° F)

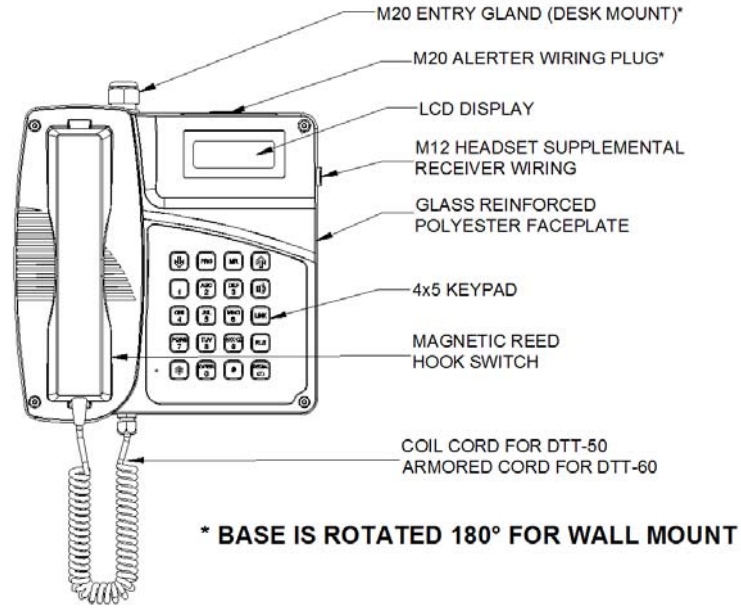

**Figure 1 - Features**

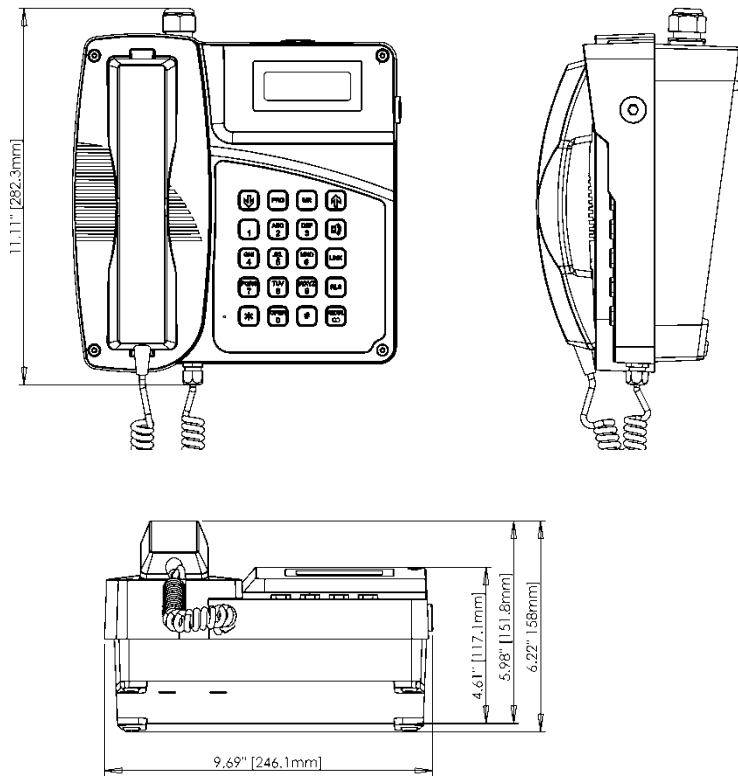

**Figure 2 - Overall Dimensions**

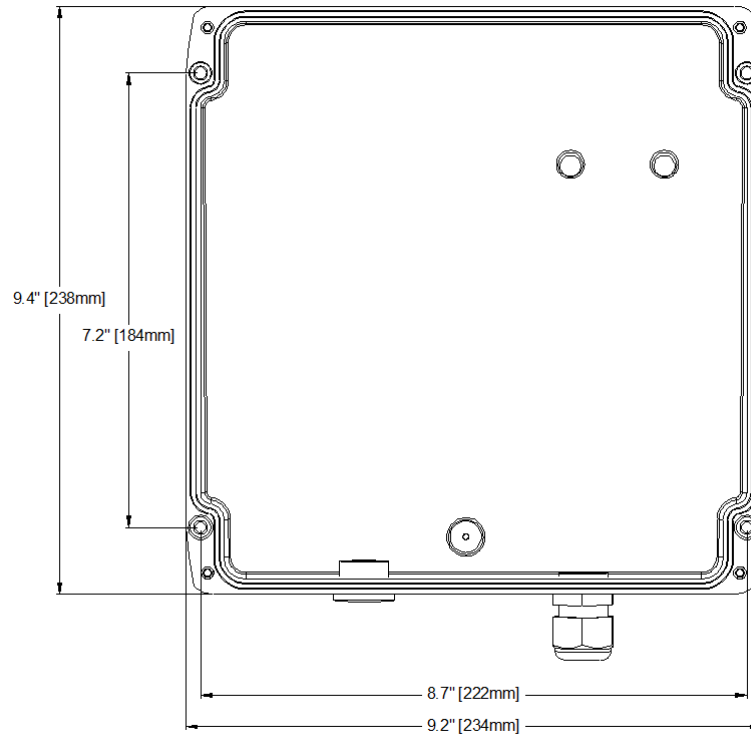

Figure 3 - Wall Installation of Base

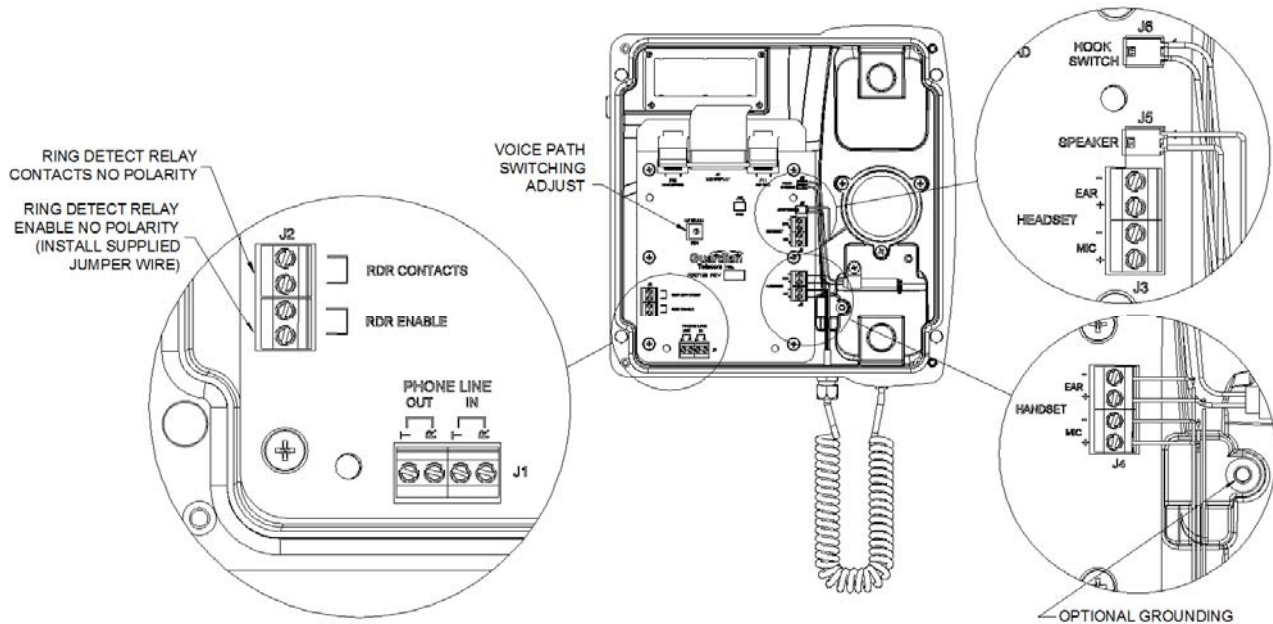

Figure 4 - Wiring

## Installation

- DTT telephones are shipped from the factory set for DTMF (Tone) dialing mode. If loop disconnect (Pulse) dialing is required program Register Number 52 appropriately.
- Follow all appropriate electrical codes and use only approved electrical fittings for the installation.
- If required install primary surge protection external to the telephone.
- Ensure that the telephone circuits are not live by disconnecting the Tip and Ring conductors at the demarcation block.
- If the built in Ring Detect Relay is to be utilized to activate an external alarm ensure that the power conductors are not live.
- Using the 3mm Allen Key provided remove the four faceplate screws to detach the faceplate from the base.
- The telephone may be installed on a flat surface or wall mounted.

### **Desk Top Configuration**

- If the telephone is to be desk top mounted set the base in the desired location.

### **Wall Mount Configuration**

- If the telephone is to be wall mounted choose a location that is free of obstructions and permits space for wiring. Mount the base with the deepest dimension on the bottom. Mount as follows:
  - The telephone weighs 3.95 kilograms (8.68 pounds), ensure that the mounting can support four times the weight of the unit; that is 15.8 kilograms (34.8 pounds). Wall anchors are not included; follow the manufacture's instructions when installing anchors.
  - Mounting to concrete or cinder block. Lead expansion anchors with M4 (#8) screws are recommended.
  - Mounting to drywall. Hollow wall anchors (Molly Bolts) with M4 (#8) screws are recommended.
  - Mounting to other surfaces. It is the responsibility of the installer to ensure that the base is attached in such a way as to support the weight specified above.
- Install the handset retainer clips on the faceplate using the hardware supplied.

*See: Operating Modes and Software Features.*

*See: Figure 2 - Overall Dimensions.*

## Wiring

- **WARNING:** Use properly sized cable to ensure a gas/dust tight seal at the cable gland to maintain an IP66 rating, (M12 – 2 to 5mm), (M20 – 8 to 13mm). *Take care not to lose parts of the gland if the cap is removed.*
- If the telephone is wall mounted hang the faceplate on the right side of the base using two of the faceplate screws. Be careful not to lose the "O" ring retainers.
- Insert the Tip and Ring cable through the M20 gland and connect the conductors to the Phone-Line-In terminal block.
- If an extension telephone is installed the phone line out terminals may be utilized. A four conductor cable can be used, or an additional cable can be run through the spare 20mm opening; if it is not occupied for other purposes.
- Install the supplemental receiver or headset if provided.
- If an external alerter device is utilized remove the M20 plug, install an appropriate cable gland and connect the wiring to the Ring Detect Relay terminal block. Enable the Ring Detect Relay by inserting the jumper wire provided across the Ring Detect Relay Enable terminals.
- Tighten the cable glands securely.
- Mount the face plate and fasten the captive screws to the base.
- Connect the Tip and Ring conductors at the demarcation block.
- If the built in Ring Detect Relay is utilized apply power to the conductors.

### Programming the DTT

- If necessary program the features.

### Testing

- Test the unit by calling to and from another unit on the exchange.

*Tip: If cable diameter is not in the range of the M12 or M20 glands provided an approved reducer and smaller gland can be fitted.*

*See: Figure 5 - Temporary Mounting for Wiring*

*See: Figure 4 - Wiring*

*See: Retrofitting Headset/Supplemental Receiver, Strobe Light/Ringer*

*Tip: Torque screws to 1.65 ft/lbs (1.36Nm)*

*See: Operating Modes and Software Features*

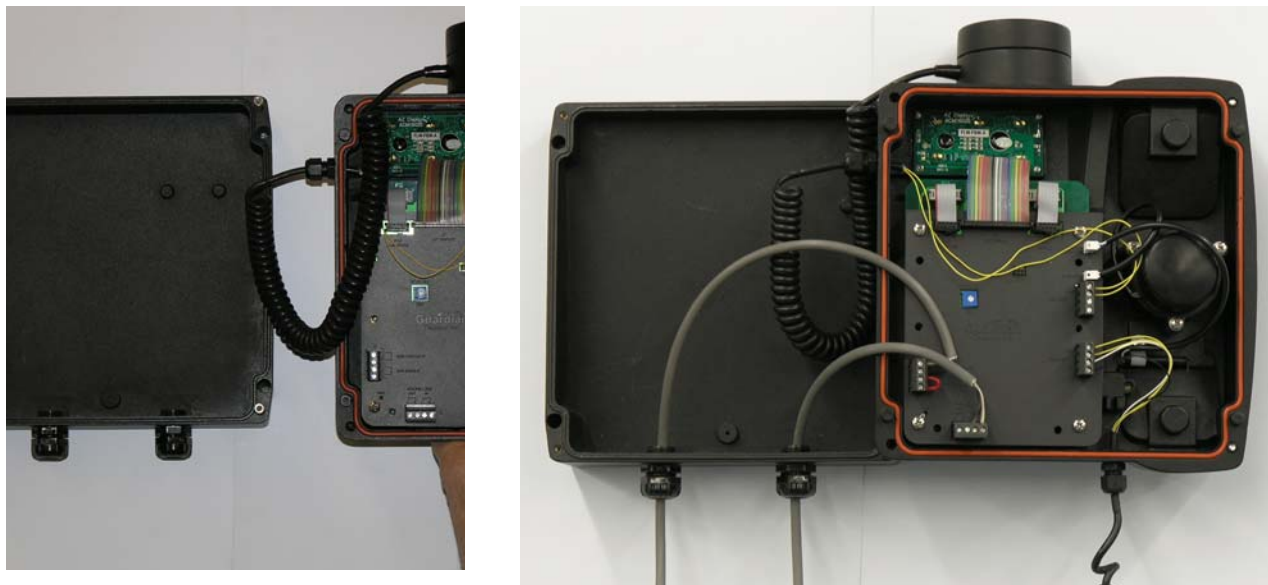

**Figure 5 - Temporary Mounting for Wiring**

## Retrofitting Headset/Supplemental Receiver, Strobe Light/Ringer

- Disconnect telephone wiring at the demarcation block and ring detect relay power at the breaker to avoid shock hazard.
- Loosen the four captive screws in the faceplate and detach the face plate from the base.
- If the telephone is wall mounted temporarily hang the faceplate to the right side of the base using two of the faceplate screws. Be careful not to lose the "O" ring retainers.
- Install the options following the instructions below.
- Tighten cable glands securely.
- Carefully replace the front plate and install all four screws.
- Reconnect telephone and ring detect relay wiring.
- Test the unit by calling to and from another unit on the exchange.

### **Headset / Supplemental Receiver**

- If wall mounted install the Headset/Supplemental Receiver hanger to the wall 4" to 6" to the right of the telephone.
- Remove the M12 plug on the side of the face plate and install the accessory cord gland.
- Insert the cord through the gland until the sleeve protrudes 1 cm into the face plate and tighten the gland securely.
- Connect the headset wiring to the headset earpiece and microphone terminal block or if the Supplemental Receiver is utilized connect the wiring to the headset earpiece terminal block connector.
- If the headset is utilized program the phone to recognize the headset (Register Number 54).

### **Strobe Light /Loud Ringer**

- Remove the M20 alerter device wiring plug from the base and install a cable gland.
- Insert the cord through the gland into the face plate or base and tighten the gland.
- Connect the Strobe Light or Loud Ringer wiring to the Ring Detect Relay terminal block.
- Enable the Ring Detect Relay by inserting the provided jumper wire across the Ring Detect Relay Enable terminals.

**See:** Figure 5 -  
Temporary Mounting  
for Wiring

**Tip:** Torque screws to  
1.65 ft/lbs (1.36Nm).

**Note:** Headset Kit  
part no. P3031 or  
Supplemental  
Receiver part no.  
P3024 required.

**See:** Figure 1 -  
Features

**See:** Figure 4 - Wiring

**See:** Operating  
Modes and Software  
Features

**See:** Figure 1 -  
Features



## Field Repairs & Adjustments

Field repairs may only be carried out by qualified technicians using OEM parts. Substitution of parts voids warranty and may pose a hazard to users of the equipment.

*See: Replacement Parts*

- Disconnect telephone wiring at the demarcation block and ring detect relay power at the breaker to avoid shock hazard.
- Loosen the four captive screws in the faceplate and detach the faceplate from the base.
- If the telephone is wall mounted temporarily hang the faceplate to the right side of the base using two of the faceplate screws. Be careful not to lose the "O" ring retainers.
- Perform the necessary repairs or adjustments.
- Carefully replace the front plate and install all four screws.
- Reconnect telephone and ring detect relay wiring.

*See: Figure 5 - Temporary Mounting for Wiring*

*Tip: Torque screws to 1.65 ft/lbs (1.36Nm).*

### **Hands-free Speaker Phone Voice Switching Adjustment**

- Locate the Voice Path Switching potentiometer.
- Adjust the potentiometer clockwise to increase the receive sensitivity.
- Adjust the potentiometer counter-clockwise to increase the transmit sensitivity.

*See: Figure 4 - Wiring*

### **Handset Replacement**

- Disconnect the handset wiring from the terminal block.
- If the phone is equipped with an armored cord handset, remove the anchor screw from the armored cord lanyard.
- Loosen the handset cable gland and pull out the cord.
- Install the new replacement and tighten the gland.
- Rewire the replacement cord to the terminal block.

*See: Figure 4 - Wiring*

### **Supplemental Receiver and Headset Replacement**

- Disconnect the supplemental receiver/headset wiring from the terminal block.
- Loosen the cable gland and pull out the cord.
- Install the new replacement and tighten the gland.
- Rewire the replacement cord to the terminal block.

*See: Figure 4 - Wiring*

### **Hands-free Speaker Replacement**

- Unplug the speaker connector from the main board.
- Remove the screws that hold the speaker cap to get access to the speaker.
- Install the new speaker and gasket.
- Reconnect the speaker connector to the main board.

### **Main Circuit Board Replacement**

- Label any wiring attached to the circuit board. Disconnect wiring and ribbon cable.
- Remove the six screws holding the circuit board in place. Carefully remove the board.
- Install the new board and replace the six screws and wiring.

*Tip: Torque screws to 2.5 in/lbs (0.28 Nm).*

**Keypad Circuit Board Replacement**

- Remove the main circuit board as described above.
- Remove and replace the keypad circuit board.
- Replace the main circuit board and wiring as described above.

**LCD Display and Keypad Membrane Replacement**









- The LCD and the keypad membrane are not replaceable in the field. The telephone must be returned to Guardian Telecom or an authorized service depot for repair.

**Fuses**











- **There are no replaceable fuses in the DTT.**
- The phone line fuse on the circuit board of all models is of the resettable type and is not replaceable. If the fuse trips due to an external event it will reset in a short period of time. The duration will depend on ambient temperature and other factors. If the fuse trips repeatedly check the telephone system wiring.
- The Ring Detect Relay fuse is a 5 Ampere, fast blow fuse potted on the circuit board. If the fuse blows the circuit board must be replaced.

*Tip: The fuse protects the Tip and Ring line from the telephone system. It is usually powered at 48 volts DC and must not be connected to 120VAC or 230VAC.*

**Key Functions****While Programming**

-  ..... Hands free mode
-  ..... Puts phone in programming mode
-  or  ... Scrolls through registers
-  ..... Returns to main register prompt
-  ..... Stores number in selected register
-  ..... Returns to main register without changing contents of selected register
-  ..... Clears selected register and switches back to main register prompt

**While Operating**

-  ..... Hands free mode or returns to on-hook
-  or  ... Scrolls through registers in Phone Book mode
-  or  ... Volume control during conversation
-  ..... Timed disconnect (same as Flash) for some CO or PABX functions
-  ..... Disconnects from phone line
-  ..... Dials number in buffer
-  ..... Displays register 0 to 9 for quick dialing
-  (twice) .. Displays register 00 to 19 for phone book dialing, can scroll with arrow keys

## Operating Modes and Software Features

### Programming Mode:

1. To enter Programming Mode take the phone off hook by removing the handset from the cradle or by pressing the [SPK] key. During the programming process do not switch Audio modes.
2. Press the [PRG] key for 1 second until a beep tone is heard and the programming prompt is shown on the display. The pass code prompt will be shown on the second line of the LCD.
3. Enter the pass code. It must be four characters long, the numeric keys, the "\*" and the "#" are valid keys. The user entered code will not be displayed on the LCD.

**Note: The telephone has provision for two pass codes, either one of which will allow access to Programming Mode. Factory settings are 1234 and 5678.**

4. Pass code check:
  - A. If the entered code is incorrect an invalid message will be shown on the second line for two seconds and the phone will go back to on hook
  - B. If the entered code matches the preset code, the phone will be in programming mode and the main register prompt will be shown:  
Enter REG #: ..  
[REG 0-19, 50-69]
5. Register number selection:
  - A: Register Code entered:

Enter a two digit register number or use the arrow keys to scroll to the desired register. Once the first number is entered the second key also has to be a number. Other keys entered following the first key (except the arrow keys and [PRG] key) will result in an invalid message being displayed on the LCD for two seconds and two alert beep tones. The LCD will switch back to the main register prompt.

Once the register number is entered it will be shown on the first line. The previous setting of the register will also be displayed:  
REGxx=xxxx
  - B. Scrolling:

The first key can be an arrow key (the [↑], and the [↓] keys). If an arrow key is activated the selected register will be shifted to the adjacent register (the next higher or lower depending on whether the entered key is the [↑] or the [↓] key). The register number will be shown on the first line and the contents of the register will be displayed. The phone is then ready to accept the register setting.

Register scrolling can run from registers 00 to 19 (phone number registers), and from 50 to 69 (feature registers). The arrow keys will shift the register within the range 00 to register 19 but will not jump to registers 50 to 69. To access registers 50 to 69 press [RLS] to get back to the main register prompt, then enter a register within the range of 50 to 69. Then use the arrow keys to scroll through registers 50 to 69.
  - C. Programming phone numbers:

If the selected register is within the range 00 to 19 it is a phone number register that can contain a maximum of twenty digits. The "#" key is counted as one digit and will be treated as a three second pause. This may be required if an access number i.e. "9" must be entered to get an outside line.

Enter the new phone number to replace the previous setting.

    - a. Use the [MR] key to store the setting to the non-volatile memory. A beep tone will be heard and the store message will be shown on the display for one second. The LCD will then switch back to the main register prompt.
    - b. Use the [RLS] key to cancel the entry leaving the previous phone number unchanged. The display will switch back to the main register prompt.
    - c. Use the [LINK] key to clear the contents of the register and switch back to the main register prompt.

**D. Programming Access Codes:**

If the selected register is 50 or 69, it is a four digit Programming Access Code register.

If desired enter a new pass code to replace the previous code. The pass code has to be four characters long. The numeric keys, the '\*' and the '#' are valid keys for pass code.

- a. Use the [MR] key to accept the new code. A second prompt will be shown with the newly entered pass code. Check and compare the pass code on the LCD display to the pass code on the programming sheet. Press the [MR] key again to store the new code to the non-volatile memory. A beep tone will be heard and the store message will be shown on LCD for one second. The LCD will switch back to the main register prompt.
- b. Press the [RLS] key to cancel the newly entered pass code leaving the existing pass code unchanged. A "Code not saved!" message will be shown for one second and the display will switch back to the main register prompt.

**Note:**

***For convenience the DTT telephone has two Access Code registers either one of which will allow entry to programming mode. If the Access Codes are to be replaced, they should be changed one at a time. Confirm the new code by using it to get into the programming mode. If the new code does not work, use the other Access Code to restore the code that was previously changed.***

***Always use the Programming Sheet to record the Access Codes.***

***If both Access Codes are forgotten the phone has to be sent back to Guardian Telecom Inc. or an authorized service center for the Access Codes to be restored.***

**E. Configuration Codes:**

If the selected register is within the range 51 to 68, it is a one digit Configuration Code register.

Use the Programming Sheet as a guide to select the settings. Enter the new code to replace the previous setting.

- a. Use the [MR] key to store the setting to the non-volatile memory. A beep tone will be heard and the store message will be shown on the display for one second. The LCD will then switch back to the main register prompt.
- b. Use the [RLS] key to cancel the entry leaving the previous Configuration Code unchanged. The display will switch back to the main register prompt.

**F. Default Settings:**

When register 51 is set at '2' all the configuration codes and the Pass Codes will remain unchanged while the phone is still in the Programming Mode. Once the phone goes from on hook to off hook again all the Configuration codes and the Pass Codes will be reset to the default settings and register 51 will be reset to '1'. The phone number registers will remain unchanged.

**G. Exiting Programming Mode:**

Press and hold the [PROG] key to exit programming mode. The exit programming message will be shown and the phone will go back to on hook.

## Programming Sheet:

Register number	Functions	Descriptions	Entered Codes	Parameters	Remarks
00	Speed dial phone numbers	Phone number at 0		Maximum 20 digit phone number	Registers 00 to 09 can be accessed for dialing by pressing MR once followed by a number 0 to 9.  Registers 00 to 19 can be accessed for dialing by pressing MR twice and entering a number 00 to 19. In addition the up/down arrows can be used to scroll through the registers. When the desired number is located pressing MR will cause the number to be dialed out.
01		“ “ “ 1			
02		“ “ “ 2			
03		“ “ “ 3			
04		“ “ “ 4			
05		“ “ “ 5			
06		“ “ “ 6			
07		“ “ “ 7			
08		“ “ “ 8			
09		“ “ “ 9			
10		“ “ “ 10			
11		“ “ “ 11			
12		“ “ “ 12			
13		“ “ “ 13			
14		“ “ “ 14			
15		“ “ “ 15			
16		“ “ “ 16			
17		“ “ “ 17			
18		“ “ “ 18			
19	“ “ “ 19				
20 - 49		Not Used			
50		First Access Code (numeric keys, *, and #)		4 characters	<b>Default = 1234</b>
51	Default Settings	1 = user, 2 = default Factory defaults: 50 = 1234 (Access code) 51 = default settings 52 = DTMF dialing 53 = English Display 54 = Speaker Mode 55 = Flash 56 = 5, Headset Mic gain 57 = 3, Handset Mic gain 60 = 60minutes Talk Time 61 = 32 dialing digits 62 = 5 hand/headset volume 63 = 5 speaker volume 64 = 1 65 = 2 66 = 6 67 = 5 TX gain 68 = 6 Rx gain 69 = 5678 (Access code)		1 digit code	When register 51 is set at '2', all the configuration codes and the Pass Codes will remain unchanged while the phone is still in the Programming Mode. Once the phone goes from on hook to off hook again, all the configuration codes, and the Pass Codes will be reset to the default settings and register 51 will be reset to '1'. Phone number registers will not be changed.  <b>Default = 1</b>
52		Dialing Modes 1 = DTMF (RS 470) 2 = DP 60:40 (10pps) 3 = DP 66:33 (10pps) 4 = DTMF (BTR 21)		1 digit code	<b>Default</b> North America = 1 Europe = 4

53		LCD Display Languages 1 = English 2 = French 3 = Spanish		1 digit code	<b>Default = 1</b>
54		Hands-free Devices 1 = speaker, 2 = headset		1 digit code	<b>Default = 1</b>
55		Timed Break 1 = 280ms, 2 = 600ms		1 digit code	<b>Default</b> Europe = 1 North America = 2
56		Headset Microphone Gain (1-8)		1 digit code	<b>Default = 3</b>
57		Handset Microphone Gain (1-8)		1 digit code	<b>Default = 3</b>
58 -59		Not used			
60		Talk time (minutes) 1 – 9 = 1 to 9 minutes 0 = 60 minutes		1 digit code	<b>Default = 0</b>
61		Max. digits in manual dialing 1-9 = 3+(1 to 9) digits, 0 = 32 digits		1 digit code	<b>Default = 0</b>
62		Handset / headset volume after reset (1 – 8) 2 dB / step		1 digit code	<b>Default = 5</b>
63		Speaker volume after reset (1 – 8) 2 dB / step		1 digit code	<b>Default = 5</b>
64		Voice switch speed between transmit & receive (1 – 4) 1= max speed 4= min speed		1 digit code. Using the factory setting recommended	<b>Default = 1</b>
65		Background noise offset level (1 – 4) 1=120mV, 2=180mV 3=240mV, 4=300mV		1 digit code. Using the factory setting recommended	<b>Default = 2</b>
66		Background noise & soft clips (1 – 8) 1 = Tx soft clip 2 = Rx soft clip 3 = Tx, Rx s.c. 4 = BGN on 5 = BGN, Tx s.c. 6 = BGN, Rx s.c. 7 = BGN, Tx, Rx, s.c. 8 = BGN off,		1 digit code. Using the factory setting recommended	<b>Default = 6</b>
67		Transmit gain (1- 8)		1 digit code. Using the factory setting recommended	<b>Default = 5</b>
68		Receive gain (1 – 8)		1 digit code. Using the factory setting recommended	<b>Default = 6</b>
69		Second Access Code (4 characters) (numeric keys, *, and #)		4 digit code	<b>Default = 5678</b>

## User Operating Mode:

When the handset is off the cradle or the [SPK] key is pressed the phone will go off hook. The LCD will display the greeting message and the current Audio mode. While the phone is off hook and it detects a Call Disconnect pulse from the CO line or PABX, the phone will go on hook, even with the handset off the cradle.

### 1. Audio Modes:

The DTT telephone has two Audio Modes Handset and Hands-free. The LCD display will show the current status of the Audio mode. The [↑] key and [↓] key are volume control keys.

Pressing these two keys will adjust the volume of the current hearing device

#### a. *Handset mode:*

When the phone is on hook or while it is off hook in Hands-free Mode, removing the handset from the cradle will set the phone to the Handset Mode. In this mode the speaker and the hands-free microphone are off. The headset receiver and microphone are off if the headset is configured to replace the speaker. The volume control keys will adjust the volume on the handset earpiece volume. The phone will go back to on hook if the handset is returned to the cradle.

#### b. *Hands-free Mode:*

When the phone is on hook, or while it is off hook in Handset Mode pressing the [SPK] key will set the phone to the Hands-free Mode. After the phone has switched from Handset Mode to Hands-free Mode returning the handset to the cradle will not put the phone on hook. The phone will go back to on hook if the [SPK] key is pressed. Hands-free Mode can be configured to Speaker Phone or Headset by setting the contents of register #54 to 1 or 2 respectively. Speaker phone capability is standard however a headset is optional.

##### i. *Speaker Phone Mode:*

When the phone is configured to Speaker Phone the hands free MIC and the speaker are on. The handset MIC and headset are off. The volume control keys will adjust the speaker volume.

##### ii. *Headset Mode:*

When the phone is configured to Headset Mode, the hands free MIC, speaker, and the handset are off. The volume control keys will adjust the volume on headset earpieces.

**Note: be sure that Register #54 is set correctly.**

### 2. Dialing Modes:

There are four signaling modes in the DTT telephone.

#### A. *DTMF dialing modes (RS 470 and BTR 21):*

In the DTMF mode, using keypad dial, redial, or Phone Book dial will result in having the phone dialed in DTMF tones.

#### B. *Pulse dialing (break/make ratio of 60:40) mode:*

In the 60:40 Pulse dialing mode, using keypad to dial, redial, or Phone Book dial will result in having the phone number dialed in pulse with the break/make of 60:40 at 10pulses/sec. In this mode the Link key (timed break key), the '\*' key, and the '#' key are not supported.

#### C. *Pulse dialing (break/make ratio of 66:33) mode:*

In the 66:33 Pulse dialing mode, using keypad to dial, redial, or Phone Book dial will result in having the phone number dialed in pulse with the break/make of 66:33 at 10pulses/sec. In this mode the Link key (timed break key), the '\*' key, and the '#' key are not supported.

3. Numeric keys, [\*] key, and [#] key on the Keypad:

While in the Operating Mode, all the numeric keys, the '\*' key, and the '#' when pressed will be dialed out, (if the phone is set to pulse dialing the [\*] and [#] keys are not supported). The maximum number of characters that can be dialed out is 32. The dialed out characters will be displayed on the LCD starting from the first character to the left on the first line and ending at the last character to the right on the second line. The dialed number on the display will be maintained for 6 seconds, then the display will switch back to show the Audio Mode status until further numeric keys are pressed.
4. The [↑] and [↓] keys:

The up and down arrow keys adjust the volume of the hearing device currently being used. Each press of these keys will increase or decrease the volume by 2 dB within a range of 15 dB. The LCD will display the current volume setting for two seconds then switch back to show the Audio Mode status.
5. [Link] key:

The [Link] key which is sometimes referred to as [Flash] will provide a timed disconnect to the current on the phone line. The period can be configured to 280ms or 600ms and is required for some Central Office or PABX functions.
6. [RLS] key:

The [RLS] key will disconnect the phone from the phone line for one second to reset the phone line for next call.
7. [Redial] key:

Pressing the [Redial] key after going off hook will dial out the last keys stored in the dial buffer. It may be different than all the keys that were pressed in the previous call. The number dialed out will be displayed on the LCD starting from the first character to the left on the first line and ending at the last character to the right on the second line. The dialed number will be displayed for two seconds then the LCD will switch back to show the Audio Mode status. The arrow keys will resume the volume control function. Subsequent keypad dialing is resumed.
8. Quick dialing and Phone Book Call:

Quick dialing and Phone Book calling must be used just after going off hook. If manual dialing is used, Quick dialing and Phone Book will be disabled.

  - A. *Quick dialing:*

There is provision for 10 Quick dialing phone numbers in the phone. To activate Quick dialing, press the [MR] key. The register number prompt will be displayed:  
Enter REG #: ..  
[REG 0 to 9]

Press one numeric key (0 to 9). The phone number in the register will be dialed out to the phone line as well as being displayed on the LCD. The dialed number will be displayed for two seconds then the LCD will switch back to show the Audio Mode status. The arrow keys will resume the volume control function. Subsequent keypad dialing is resumed.
  - B. *Phone Book dialing:*

There are twenty phone numbers in the Phone Book including the 10 Quick dialing phone numbers. To activate the Phone Book press [MR] twice. The register number prompt will be displayed:  
Enter REG #: ..  
[Phone List]



Enter a two digit number or use the arrow keys to scroll through the register. The associated phone number will be displayed.

Use the [↑] or [↓] keys to shift through the Phone Book.

Press [MR] key to dial out the current register phone number.

The dialed number will be displayed for two seconds then the LCD will switch back to show the Audio Mode status. The arrow keys will resume the volume control function. Subsequent keypad dialing is resumed.

**Note:**

***When a phone number register is clear, calling it through Quick dial or Phone Book dialing will result in no dialing at all.***

***All phone number registers that are not used should be cleared.***

9. Time out:

The time out counter will enforce a fixed call duration which is programmable from between 1 minute to 9 minutes, or alternatively 60 minutes, starting from the moment the phone is off hook. It will generate 3 beep tones, and display a time out message on the LCD ten seconds prior to disconnecting the call. This feature is applicable in both Handset and Hands-free modes. This feature is useful when the user forgets to return the handset back to the cradle, or does not press the [SPK] key to hang up the call while the phone is in the Hands-free Mode.

(This feature can set to maximum 60 minutes).

After time out the phone is disconnected from the phone line. The phone will ring when there is an incoming call. The handset has to be returned to the cradle for the phone to be used in handset or hands-free mode to answer the call.

<b>Product Specifications</b>	
<b>Performance</b>	
AUDIBLE RANGE FREQUENCY RESPONSE	300 – 3400 HZ
HANDS FREE SPEAKER OUTPUT (MAX @ 1KHZ)	~85dB @ 1 METER
RECEIVER VOLUME ADJUSTMENT	8 STEPS, 2 dB/STEP
SPEED DIAL	10 REGISTERS OF 20 DIGITS EACH
PHONE BOOK DIAL	20 REGISTERS OF 20 DIGITS EACH, (INCLUDES SPEED DIAL NUMBERS)
FLASH	280/600 mSEC TIMED DISCONNECT
REDIAL	32 DIGITS MAXIMUM
<b>NORTH AMERICAN CONFIGURATION</b>	
DIALING METHOD	DTMF OR 40:60 PULSE AT 10 PPS
<b>EUROPEAN CONFIGURATION</b>	
DIALING METHOD	DTMF OR 33:66 PULSE AT 10 PPS
CONFORMS TO	RESIDENTIAL AND INDUSTRIAL AREAS ETSI TBR 38: MAY 1998 (ACOUSTICS) ETSI TBR 21: JANUARY 1998 (TELEPHONE NETWORK)
<b>Electrical</b>	
RINGER SENSITIVITY	40 – 100 V, 16 – 25 HZ
LINE VOLTAGE	24 – 56 VDC
LOOP CURRENT	22 - 100 mA
CONNECTION METHOD	TERMINAL BLOCKS
FUSE - MAIN TELEPHONE CCT	250 mA – AUTO RESET
FUSE – RING DETECT RELAY	5 AMP 250 VOLT FAST BLOW
RINGER OUTPUT	>85 dB @ 1M
RINGER IMPEDANCE WITHOUT RING DETECT RELAY	>7K OHMS @25 Hz, 30-90 VAC >4K OHMS @ 50Hz, 30-90 VAC
RINGER IMPEDANCE WITH RING DETECT RELAY	>4K OHMS @25 Hz, 30-90 VAC (RDR NOT RECOMMENDED @ 50Hz)
SET IMPEDANCE	600 OHMS NOMINAL
MAXIMUM LOOP	15,000 FT (4,600 M) OF 22 AWG COPPER
<b>Environmental</b>	
INGRESS PROTECTION RATING	IP66
OPERATING TEMPERATURE	-30° TO +60° C (-22° TO +140° F)
STORAGE TEMPERATURE	-50° TO +80° C (-58° TO +176° F)
HUMIDITY	0 TO 95% RH
DUSTPROOF	FULLY GASKETED ENCLOSURE
<b>Mechanical</b>	
HOOK SWITCH (CRADLE SWITCH) LIFE	>1 000 000 OPERATIONS
HOUSING MATERIAL	GLASS FILLED POLYESTER (CARBON LOADED)
HANDSET MATERIAL	GLASS FILLED POLYESTER (CARBON LOADED)
DIMENSIONS (H X W X D) WALL MOUNTED	282 x 246 x 158 MM (11.1 x 9.7 x 6.2 INCHES)
NET WEIGHT	3.95 KG (8.68 LBS)
MOUNTING WALL STRENGTH REQUIREMENT	15.8 KG (34.8)LBS
MICROPHONE	NOISE CANCELING
RECEIVER	HEARING AID COMPATIBLE (HAC)
MOUNTING	DESK OR WALL
WIRING ACCESS	2 x M20 & 1 x M12 CABLE GLAND ENTRY POINTS

<b>Compliance</b>	
	CE
ENVIRONMENTAL	IP-66
	ROHS COMPLIANT

<b>Replacement Parts</b>	
<b>Part No.</b>	<b>Description</b>
P3025	DTT Replacement Handset c/w curly cord.
P3026	DTT Replacement Handset c/w armored cord.
P002254	Magnetic reed hook switch
P004123	Nylon fastener for hook switch
P006582	Membrane Gasket for Handset Microphone.
P006583	Membrane Gasket for Handset Receiver.
P006690	M20 Gland, ATEX compliant
P006668	M20 Plug, ATEX compliant
P006679	M12 Gland, ATEX compliant
P006862	M12 Plug, ATEX compliant
P006692	M4 Faceplate screws (4 required)
P006696	O-Ring gaskets for faceplate screws (4 required)
P006675	Faceplate gasket (do not order if purchasing P007335 as it is included)
P007191	Molded cover for encapsulated circuit board.
P007198	Main Circuit board for desk top telephone, encapsulated.
P007199	Keypad circuit board with HF microphone
P007335	Replacement Faceplate c/w Keypad membrane, LCD, gaskets.
P007177	Telephone housing base
P006819	Speaker
P006614	Handset retainer (qty 2 required)
P006617	Allen key for faceplate screws

## **Warranty**

Guardian Telecom warrants your product to be free of defects in material and workmanship for a period of one year. Guardian Telecom will repair or replace any defective unit that is under warranty free of charge.

This warranty is null and void if any non-authorized modifications have been made to this product, or if it has been subjected to misuse, neglect, or accident. This warranty covers bench repairs only; such repairs must be made at Guardian Telecom or an authorized service depot. Guardian Telecom is not responsible for costs incurred for on-site service calls, freight, or brokerage.

***A return authorization must be obtained prior to warranty claims or repairs.***

## **Disclaimer**

The products covered by this manual are designed for use in Industrial Environments and/or Hazardous Locations. Due to the range of possible applications for these instruments the manufacturer will not be responsible for damages or losses of any kind suffered as a result of the use of this product, including consequential damages.

## **Warning**

This device may be opened and reassembled by qualified personnel only, for the purposes of installing the product, making adjustments and replacing components, following the instructions in the product manual. Before opening this telephone disconnect the wiring at the demarcation block.

**High voltages may be present in this product when connected to telephone wiring.**

## **Service Telephone Number**

### ***1-800-363-8010***

Guardian Telecom provides a customer service telephone number which is toll-free within North America. If you need assistance when installing or operating this product, please call the toll-free telephone number between regular business hours (8:00AM-5:00PM), Mountain Standard Time. If you are calling outside of regular business hours, please leave a detailed message, and a member of Guardian Telecom's Service Department will return your call as soon as possible. If your product requires service, Guardian personnel will supply you with an RMA (return materials authorization) number over the telephone or through our web site product return page. This number must be included with your return address and the name of the person to contact.

**Guardian Telecom Inc.  
Toll-free 1-800-363-8010  
Ph. (403) 258-3100  
Fax. (403) 253-4967  
[www.guardiantelecom.com](http://www.guardiantelecom.com)**

## **Feedback**

Guardian Telecom continually strives to make reliable, durable, and easy to use products. If you, as an installer or user of our equipment, have any suggestions for improvements to this or any of our products or documents, including this manual, we would appreciate hearing from you.

## Guardian Product Return

Guardian products have been quality tested and are in full working order when shipped from the factory, given the rugged nature of these products shipping is not expected to damage a unit. In the unlikely event of a malfunction, Guardian follows the three step procedure below.

### ***Step I - On-Site Correction***

- The most common source of difficulties with a new product is improper installation in one of two ways: incorrect wiring connections or connection to an incorrect power source.
- Product wiring needs to be properly connected to the on-site wiring. Correct wiring instructions are shown in the user manual included with the product.
- Connecting a telephone to a standard power source, rather than tip & ring, will trip the telephone's internal resettable fuse. In the event that the fuse trips, disconnect the telephone from the power source and reconnect following the wiring diagrams provided with the product.

### ***Step II - Return Materials Authorization (RMA)***

- When a product has been installed following user manual instructions, and the unit fails to operate, the user must contact Guardian Telecom to obtain authorization to return the product. This can be done by completing a RMA form online at [www.guardiantelecom.com](http://www.guardiantelecom.com), or by calling the service telephone number given in this manual.
- After providing information on the product, the owner and the nature of the problem, Guardian will issue a RMA number, to be shown on documentation returned with the product.
- In addition to the RMA number, shipping documents should include name, address and telephone number of the owner along with contact information for the person responsible for the repair and/or the user who identified the malfunction.
- (Where a product is being returned for repair from outside of Canada, customs documentation must show the product's serial number, date of export [date of purchase], and a notation that the equipment is: "Canadian goods returning.")

### ***Step III - Factory Authorized Service***

- Once received, each product is carefully inspected and tested. If the product is under warranty, repairs are completed and the product returned to the owner, generally within five working days of receipt by the factory.
- A product that has been subjected to misuse, neglect or accident or is beyond the warranty period will be evaluated. The service department will provide the owner's representative with a repair cost estimate. Once approved, repairs are completed and the product returned, generally within five working days.

## **Cleaning Tips for Guardian Telephones**

Guardian Telephones may occasionally need to be cleaned to maintain appearance. Generally, wiping the surface with a clean, water dampened cloth will remove most films or residues. If the soiling is too stubborn for plain water, a mild detergent solution may be used. Be sure to wipe away any detergent residue with a plain water dampened cloth. The Telephone may be cleaned with any general-purpose household glass and surface type cleaner. Do not spray the telephone directly! Spray the cleaner on a soft cloth then wipe the surface. Pre-treated cloths, like those used for eyeglasses or cameras, may be used to clean the Telephone. Premoistened towelettes may also be used, however, avoid those containing lanolin or aloe as they will leave a slippery residue. The handset and surface of the telephone may be cleaned with disinfectants used for general cleaning in a medical environment. Isopropyl alcohol may be used applied with a cloth. Avoid using alcohol on silicon based keypads, since doing so may significantly degrade legibility.

- Do not use furniture polishes, waxes or plasticizer-based cleaner (Armor All etc.)
- Do not use lanolin, aloe, glycerin or other skin care type products.
- Do not apply any solvent such as acetone, mineral spirits etc.
- Do not directly spray or immerse the handset.





**Guardian Telecom Inc.**  
**Toll-free 1-800-363-8010**  
**Phone (403) 258-3100**  
**Fax. (403) 253-4967**  
**[www.guardiantelecom.com](http://www.guardiantelecom.com)**  
**E-mail: [sales@guardiantelecom.com](mailto:sales@guardiantelecom.com)**  
*(CTRL + Click to open message box)*

***CONNECTED. PROTECTED.***

© Guardian Telecom Inc. 2015